



The **NIBBLER**®

RESIDENTIAL AND LIGHT COMMERCIAL OPERATION AND MAINTENANCE MANUAL

TABLE OF CONTENTS

Introduction

Section I - Unit Description

Components List

Operational Description

Section II - Operations & Maintenance

Inspection & Maintenance

Troubleshooting

Appendix A - Example Systems

NIBBLER[®] CBP – 1 Unit, 2 Units, & 3 Units

Appendix B - Blower Specifications

Appendix C - Field Checklist Form

Appendix D - Glossary

INTRODUCTION

The NIBBLER[®] CBP is a device that is inserted into your septic tank, which is installed at the outlet of the tank and can perform three basic functions:

Provides wastewater treatment (reducing the waste strength being discharged to the drainfield)

Discharges a flow high in dissolved oxygen - improving the drainfield efficiency

“Lifts” and recirculates sewage to the first compartment for enhanced treatment

Section I
Unit Description

COMPONENTS LIST

Blower	A one-eighth horse power blower for one CBP or a one or two PODS. And a third horse power blower for three PODS delivers the air. The blower is designed to run continuously. It should have a fine mesh screen (1/16") over the inlet to the blower
Air Supply Line	The airline delivers air to the riser containing the NIBBLER [®] CBP.
Flex Line	The flex line and union are the final adjustable connection to the air supply line and the internal air line that delivers to the draft tube.
PVC CAGE	The removable PVC cage holds draft tube and the trickle media.
Draft Tube	A 3" PVC tube centered in the 18" PVC vault. Air discharged in the draft tube, displaces liquid in the tube and forces it out the top.
Air Manifold	The air manifold is unit with multiple orifices for flushing the lower media.
Submerged Media	Submerged media are 3.5" round plastic spheres contained in the vault below the liquid level. This media provides surface area for microorganisms to attach.
Legs	PVC legs hold the unit off the bottom of the tank.
Vault	The unit is contained within an 18' diameter PVC vault.

OPERATIONAL DESCRIPTION

Raw sewage enters the septic tank at the inlet. In moving through the tank, settling and partial separation of solids occurs. Some tanks have a baffle wall that splits the tank into two compartments. The NIBBLER[®] CBPs are typically mounted at the outlet of the tank, which would be in the second compartment of a two-compartment tank.

Liquid is drawn into the NIBBLER[®] CBP through the bottom of the unit and into the submerged media and oxygenated zone within the vault. Wastewater passes through the media and is drawn into the draft tube in the center of the vault. The air released into the unit forces the flow out the top of the draft tube. This may be observed as the liquid splashes out the top, similar to the effect of a coffee percolator. This splashing effect also re-circulates the sewage around the second compartment of the tank aiding in the distribution of oxygen.

A portion of the flow discharged by the draft tube is collected and distributed by the discharge spoon mounted at the top of the unit. The spoon collects a metered portion of the flow and then discharges it to the first compartment. The amount of flow discharged is determined by the amount of spoon exposed to the flow bubbling out the top of the unit. The re-circulated sewage aids in odor control and enhances the treatment process.

The CPB units are equipped with the center air discharge in the draft tube and with a lower air manifold. As discussed in the previous section the center draft tube moves and oxygenates the sewage while the lower air manifold assists in scrubbing the media and providing an additional source of oxygen.

Section II
Operations & Maintenance

INSPECTION & MAINTENANCE

The NIBBLER[®] CBP system is a living environment that must be kept healthy to efficiently do its job. In order to do this and also meet the terms of the NIBBLER[®] CBP warranty, there is a minimal amount of inspection and service that needs to be regularly performed. We recommend inspecting NIBBLER[®] CBP system at least every six months.

1. Site Observation

- A. Before opening the system, look around for any wet areas or patches of lush green grass near the chamber. This may mean there is a broken pipe or a loose or damaged riser lid. Listen for a low splashing noise (prior to opening the unit)
- B. A properly operating system should not have an odor. If you smell an obvious odor before the lid is opened, check to make sure that the lid is tight and not damaged. If this is not the cause of the odor, the system may be biologically overloaded or the vent line may be blocked. To mitigate any such odor, proper venting is recommended.
- C. Also before opening the lid, listen closely for a gurgling sound - an indication that the NIBBLER[®] CBP unit is properly percolating effluent out the top. If a faint gurgling sound cannot be heard through the lid, check to be sure the blower is running.

2. Open Lid & Inspect the Unit

- A. When opening the lid, you should see treated effluent splashing up and out of the center tube and raining onto the top of the unit. If the treated wastewater is not splashing, the blower may not be working properly.
- B. After lifting lid take notice immediately to see if black specs are mixed in with the sewage percolating out the draft tube. The presence of black specs indicates that the unit is not ventilated properly.
- C. If the blower is not running, check the breakers to make sure power is being delivered to the unit.
- D. If the blower is running but not pumping air into the system, it may be running in reverse. To solve this problem, turn the fan off and manually spin it in the opposite direction it was running and then turn the power back on.
- E. Check to be sure that the intake filter is clean and that the source of fresh air is not blocked

3. Check Liquid Level & Measure Dissolved Oxygen

- A. If the blower is working properly you will next want to check the flood level in the tank. The liquid level in the tank should be at the invert of the outlet pipe.
- B. If the flood level in a Lift model is too high, check to see if there is a blockage between the outlet and any downstream components.
- C. If the liquid level is more than 2” below the invert of the outlet the venting may be blocked, Investigate the venting to be sure its not blocked.
- D. If instruments are available, measure and record the Dissolved Oxygen (DO) level from effluent splashing out the draft tube. Lower DO levels (e.g., under 2.0 mg/L) is an indication that the NIBBLER[®] CBP unit is not performing as well as should be expected and may need cleaning. Measure the pH and Temperature; A pH below 6.0 indicates system toxicity from medication or chemicals.

4. Measure Sludge and Scum Levels

- A. Using a Sludge Judge or other device, measure the sludge and scum levels in the first compartment of the septic tank. The combined sludge and scum level should not occupy more than 30 % of the tank capacity.
- B. The sludge level should not come closer than 2” from the NIBBLER[®] CBP vault bottom.
- C. The sludge or scum levels in the first compartment should not comprise more than 30 % of the working volume.
- D. If sludge or scum levels should exceed those recommended, the tank should be pumped.

5. Inspect Media

- A. A properly operating unit will have a small amount of growth clinging to the media in the upper region but will not be so thick that it reduces flow. If the growth is black or hinders flow through the media, the media in the upper region should be cleaned.

6. Cleaning the Media

- A. Turn off the draft tube air supply and activate the lower flushing manifold.
- B. Allow the lower flushing manifold to operate for 20 minutes.
- C. Turn on the draft tube air supply and turn off the lower flushing manifold.

D. Wash down the upper media with a hose and jet nozzle.

E. Replace the lid and clean up the surrounding area.

TROUBLESHOOTING

Odors

- Risers or lids may be leaking.
- System may be vented through plumbing
- Venting pipe may be clogged.
- Bark filter requires new bark.
- Media has excessive biological growth.
- System may be biologically overloaded or may have encountered a toxic shock.

Increase air to the unit

Connect inlet side of tank to the treatment side

To mitigate any such odor, proper venting through a chambered bark or carbon filter is recommended.

Insufficient Splashing Out the Draft Tube

- Check the liquid level in the tank. If the liquid level in the tank is 8" below the top of the 3" gravity discharge pipe, this may be a normal operating condition (low flow condition).
- Check to make sure the blower is running. If the blower is not running, check the breakers to make sure power is being delivered to the unit.
- Check the inlet screen to the blower. Clean if necessary.
- Check to be sure the fresh air source is not obstructed.
- If the blower is running but not pumping air into the unit, it may be running in reverse. To solve this problem, turn the fan off and manually spin it in the opposite direction it was running and then turn the power back on.
- Media may be clogged. Check the submerged media and if necessary, clean it.
- Check the line between the blower and the unit for leaks or breaks.
- Check to the air supply valves are in the correct position.
- Check to be sure the vent line is not plugged.

Liquid Level Too High

- Check for ponding in the drainfield
- If the flood level is too high, check for obstructions downstream.
- Groundwater may be leaking into the tank.
- The home may be using excessive amounts of water. Check water use records or pump data if available.

Liquid Level Too Low

- Check for venting blockage as the tank may be pressurized
- The tank may have a leak.

Appendix A

Example Systems



3-CBP
AquaTest NIBBLER® CBP COMPONENTS 1-800-221-3159

NOTE:
 ALL NIBBLER® CBP COMPONENTS SHALL BE OBTAINED
 AS A PACKAGE FROM AquaTest Inc. 1-800-221-3159

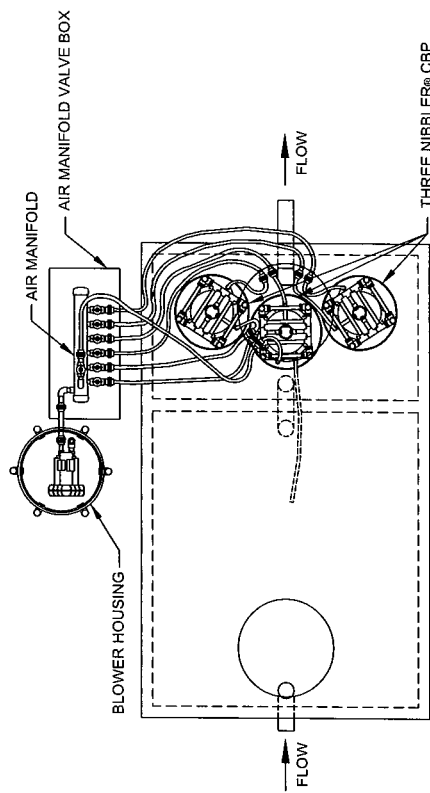

PLAN VIEW
 NTS

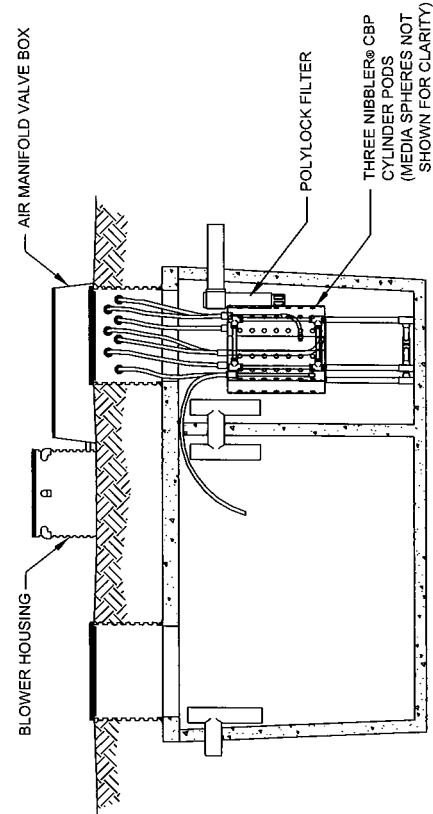

ELEVATION
 NTS

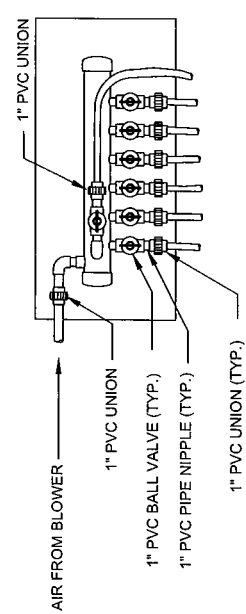

AIR MANIFOLD VALVE BOX DETAIL
 NTS

AquaTest NIBBLER® CBP COMPONENTS	
QTY.	DESCRIPTION
3	AquaTest NIBBLER® CBP UNIT
3	SET NIBBLER® CBP LEGS
3	NIBBLER® CBP STABILIZER
1	NIBBLER® CBP PORT MANIFOLD - 6 PORTS
14	1" UNION
7	1" GROMMET
50 FT.	1" PVC FLEX LINE
1	GAST BLOWER R2103
1	BLOWER HOUSING
1	BLOWER FILTER SCREEN ASSEMBLY
2	1" MALE ADAPTOR
6	1" PVC PIPE NIPPLE - 2" LONG
1	MANIFOLD VALVE BOX



AQUA TEST
 INCORPORATED
1-800-221-3159

DESIGNER	
PROJECT	
ADVISORS	
TITLE	3 - CBP
NO. SCALE	DATE
	REV. 2008
	SHEET
	4 OF 2



3-CBP
AquaTest NIBBLER® CBP COMPONENTS 1-800-221-3159

NOTE:
 ALL NIBBLER® CBP COMPONENTS SHALL BE OBTAINED
 AS A PACKAGE FROM AquaTest Inc. 1-800-221-3159

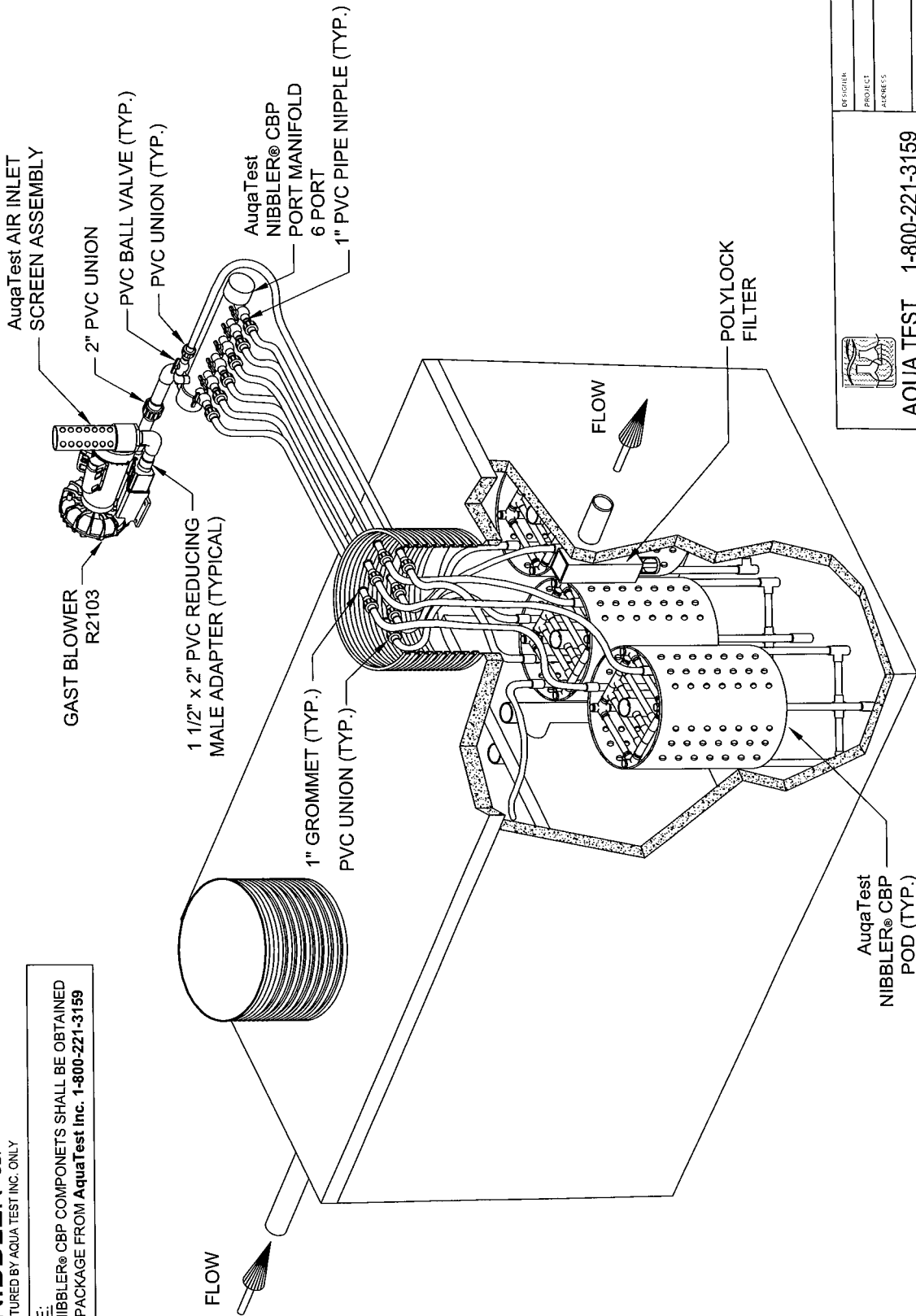

AQUA TEST
 INCORPORATED
 1-800-221-3159

DESIGNER	
PROJECT	
DATE	
TITLE	3-CBP
NO. SCALE	
DATE	NOV. 2004
SHEET	2 OF 2

Copyright Aqua Test Incorporated - All Rights Reserved



2-CBP AquaTest NIBBLER® CBP COMPONENTS 1-800-221-3159

NOTE:
ALL NIBBLER® CBP COMPONENTS SHALL BE OBTAINED
AS A PACKAGE FROM AquaTest Inc. 1-800-221-3159

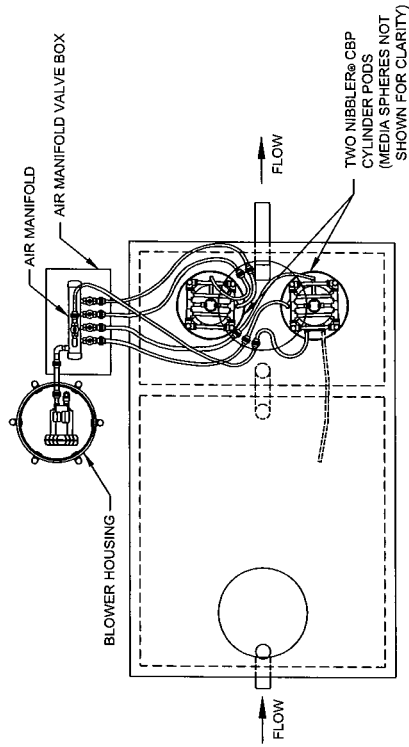

PLAN VIEW
NTS

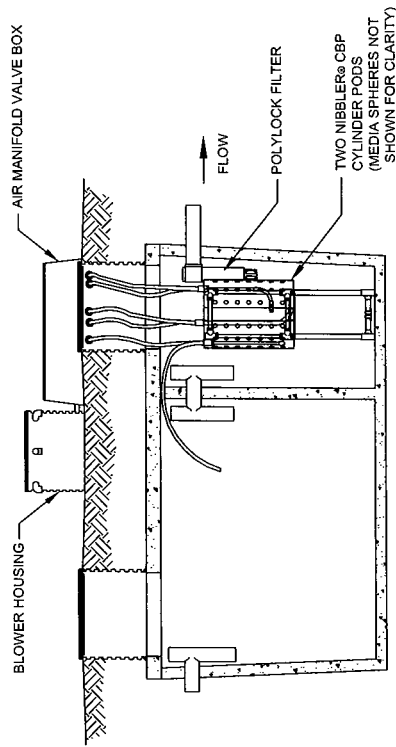

ELEVATION
NTS

2-CBP
(MINIMUM 1000 GAL. EXISTING TANK)

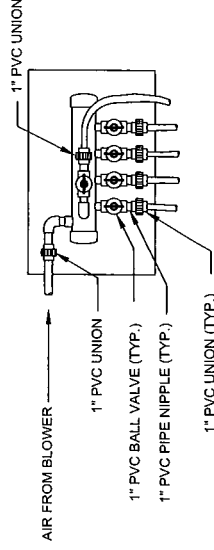

AIR MANIFOLD VALVE BOX DETAIL
NTS

AquaTest NIBBLER® CBP COMPONENTS	
QTY.	DESCRIPTION
2	AquaTest NIBBLER® CBP UNIT
2	SET NIBBLER® CBP LEGS
2	NIBBLER® CBP STABILIZER
1	NIBBLER® CBP PORT MANIFOLD - 4 PORTS
10	1" UNION
5	1" GROMMET
30 FT.	1" PVC FLEX LINE
1	GAST BLOWER R1110
1	BLOWER HOUSING
1	BLOWER FILTER SCREEN ASSEMBLY
2	1" MALE ADAPTOR
4	1" PVC PIPE NIPPLE - 2" LONG
1	MANIFOLD VALVE BOX



AQUA TEST
INCORPORATED
1-800-221-3159

DESIGNER	
PROJECT	
ADDRESS	
TITLE	2-CBP
NO. SCALE	
DATE	
SHEET	
1 OF 2	



MANUFACTURED BY AQUA TEST, INC. ONLY

NOTE:
ALL NIBBLER® CBP COMPONENTS SHALL BE OBTAINED
AS A PACKAGE FROM AquaTest Inc. 1-800-221-3159

2-CBP AquaTest NIBBLER® CBP COMPONENTS 1-800-221-3159

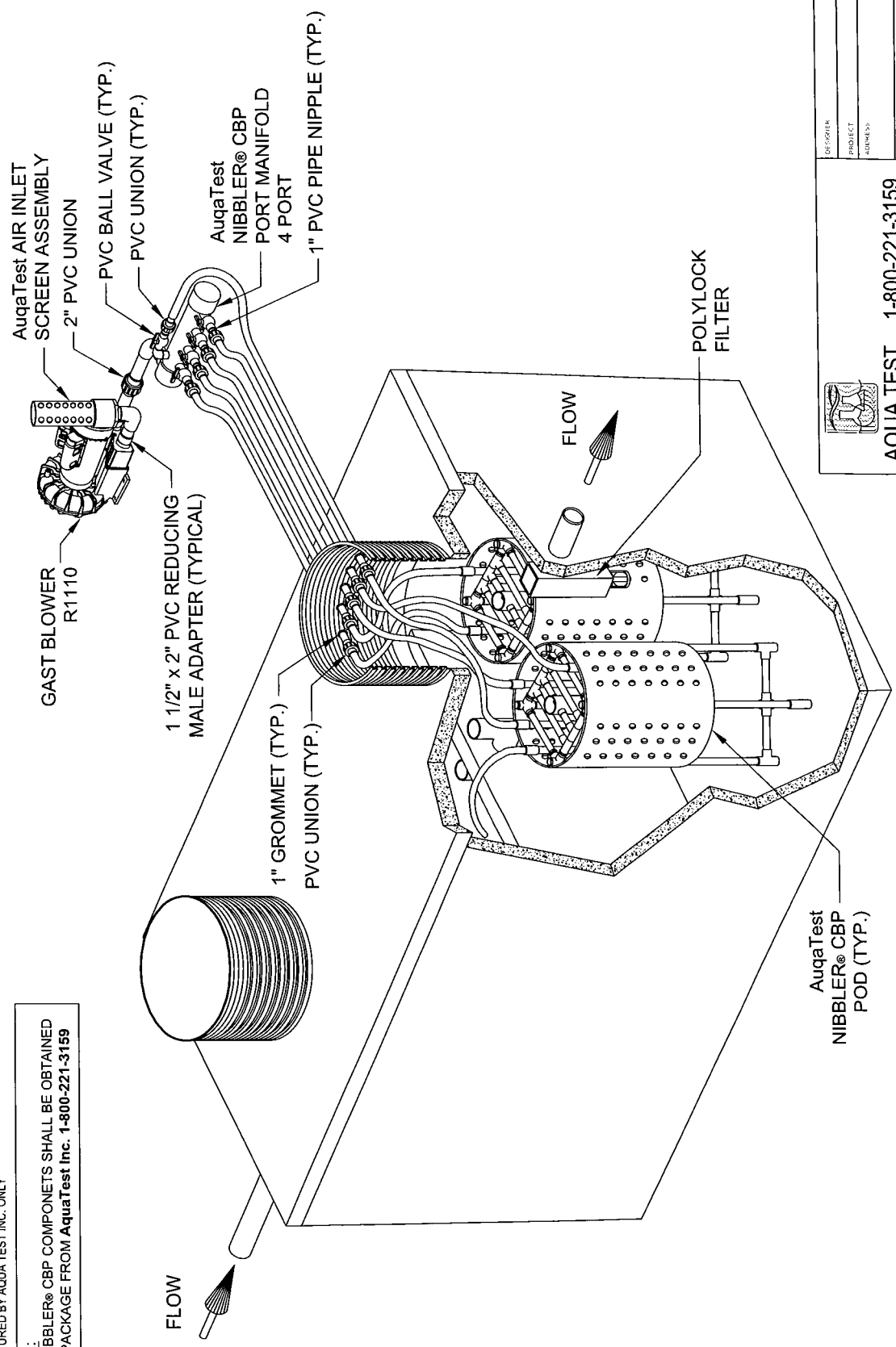

AQUA TEST
INCORPORATED
1-800-221-3159

DESIGNER	DATE	NOV. 2008
PROJECT		
CLIENT		
TITLE	2-CBP	SHEET
NO. SCALE		2 OF 2

Copyright Aqua Test Incorporated - All Rights Reserved



1-CBP AquaTest NIBBLER® CBP COMPONENTS 1-800-221-3159

NOTE:
ALL NIBBLER® CBP COMPONENTS SHALL BE OBTAINED
AS A PACKAGE FROM AquaTest Inc. 1-800-221-3159

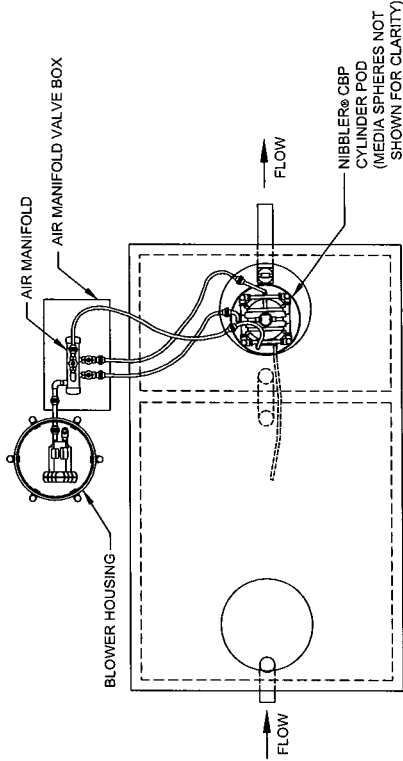

PLAN VIEW
NTS

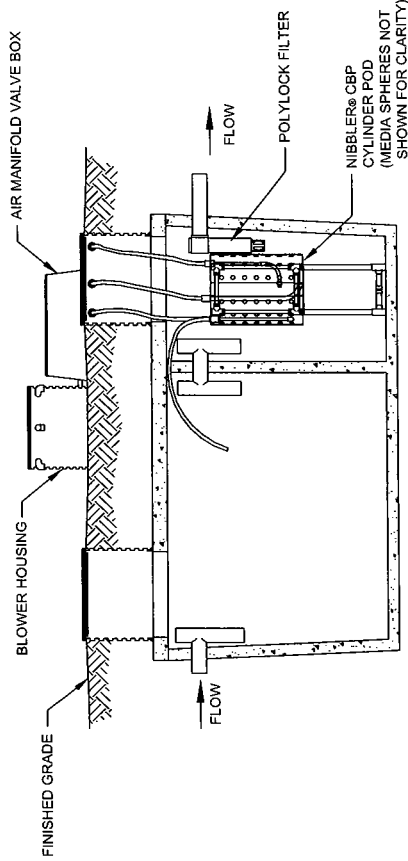

ELEVATION
NTS

1-CBP
(MINIMUM 1000 GAL. EXISTING TANK)

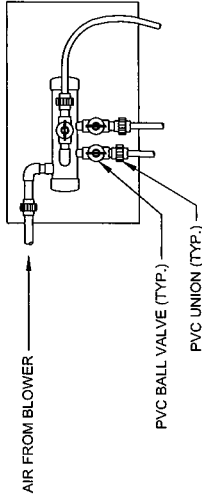

AIR MANIFOLD VALVE BOX DETAIL
NTS

QTY.	DESCRIPTION
1	AquaTest NIBBLER® CBP UNIT
1	SET NIBBLER® CBP LEGS
1	NIBBLER® CBP STABILIZER
1	NIBBLER® CBP PORT MANIFOLD - 2 PORTS
3	1" UNION
3	1" GROMMET
20 FT.	1" PVC FLEX LINE
1	GAST BLOWER R1102
1	BLOWER HOUSING
1	BLOWER FILTER SCREEN
2	1" MALE ADAPTOR
2	1" PVC PIPE NIPPLE - 2" LONG
1	MANIFOLD VALVE BOX



AQUA TEST
INCORPORATED
1-800-221-3159

REV. SHEET
PROJECT
ADDRESS

TITLE: 1-CBP
NO. SCALE
DATE: NOV 2004
SHEET: 1 OF 1



MANUFACTURED BY AQUA TEST INC. ONLY

NOTE:
ALL NIBBLER® CBP COMPONENTS SHALL BE OBTAINED
AS A PACKAGE FROM AquaTest Inc. 1-800-221-3159

1-CBP
AquaTest NIBBLER® CBP COMPONENTS 1-800-221-3159

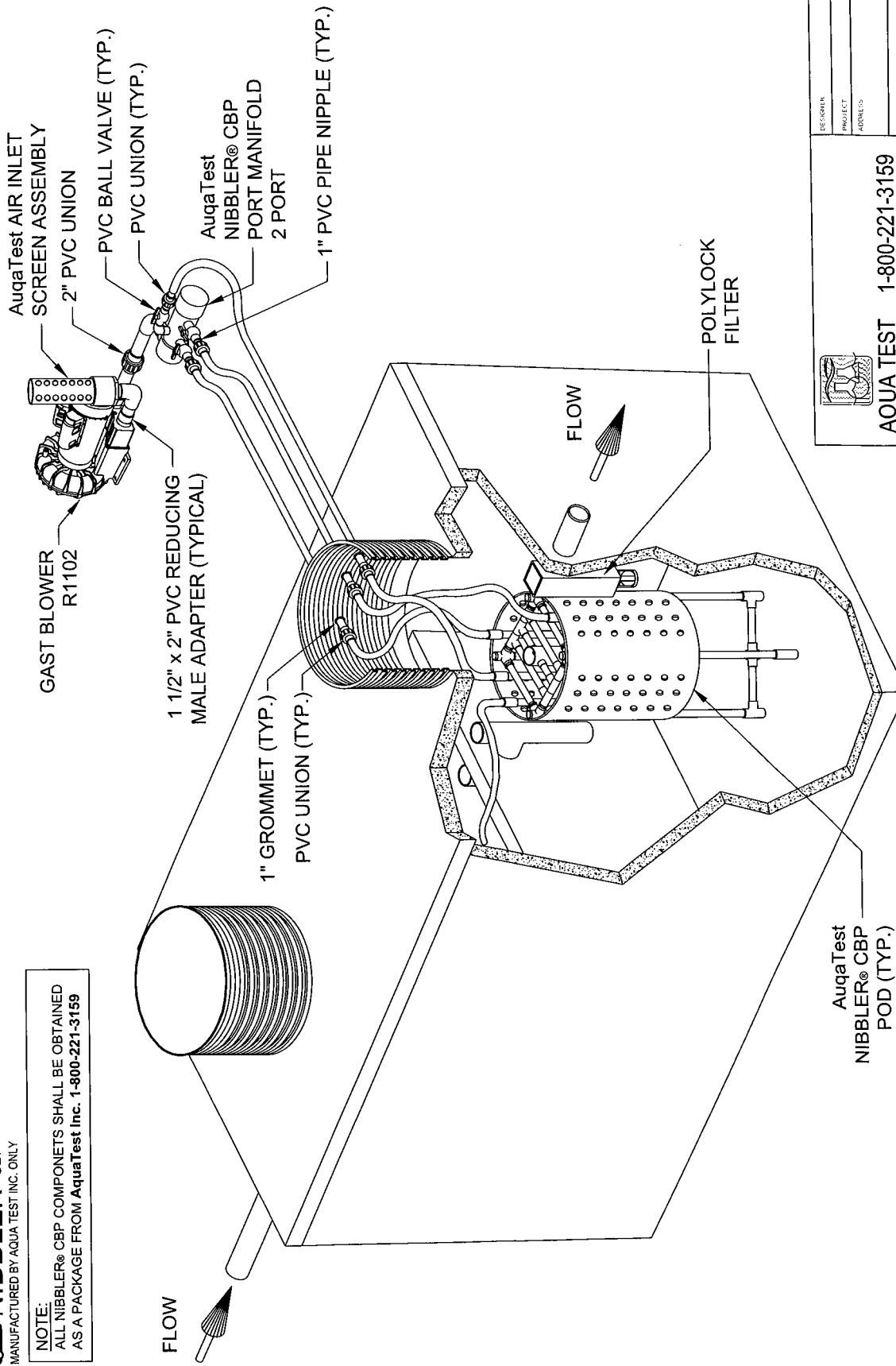

AQUA TEST
INCORPORATED
1-800-221-3159

DESIGNER	
PROJECT	
ADDRESS	
TITLE	1-CBP
NO. SCALE	
DATE	NOV. 2004
SHEET	2 OF 2

Copyright AquaTest Incorporated - All Rights Reserved

Appendix B

Blower Specifications



Blower System Design Tips

In order to utilize your regenerative blower most efficiently, proper system design is essential. The most important thing to recognize is that by utilizing large diameter plumbing, friction losses in plumbing can be greatly reduced. Here are some guidelines to use when setting up your blower system:

1. The plumbing should at least be the same size as the blower port or ideally one size larger (example - blower has ports that are 1-1/2" NPT, plumbing should be 2" NPT). The plumbing should remain this size until it has reached the location of the work area.
2. Plumbing for Separate Drive Blowers operating above 3500 RPM should be at least one pipe size larger than the blower ports.
3. Elbows create additional friction which causes pressure loss and back pressure. Plumbing at least one pipe size larger than the blower pipe ports minimizes the friction loss they create.
4. The pressure/vacuum relief valve should be installed in a "T" which is at least one pipe size larger than that of the exhaust of the blower. To properly protect a large horsepower blower, set the relief value to limit the blowers duty to 5 in. H₂O below its continuous duty rating.
5. Operating the blowers at high altitude decreases their maximum pressure or vacuum duty rating. If this is a consideration, review the information on Fan Laws in the Application Engineering section of this catalog.
6. The exhaust air temperature of the blowers increases with increasing duty. At duties over 70 in. H₂O it is too hot for most plastic pipe. Metal pipe must be considered. To prevent danger of burns, access to these pipes should be limited, guarded or marked "Danger Hot."

Performance Data

The performance data shown in this catalog was determined under the following conditions:

- Line voltage @ 60 Hz. 230V or 460V for three-phase units. 115V or 230V for single-phase units.
- Line voltage @ 50Hz. 220V for three-phase or single-phase units.
- Units in a temperature stable condition.
- Delivery measurements made with output port throttled.
- Suction measurements made with input port throttled.
- Test Conditions: Inlet air density at 0.075 lbs. per cu.ft. [20°C (68°F), 29.92 in. Hg (14.7 PSIA)].
- Normal performance variations on the resistance curve within ± 10% of supplied data can be expected.

Pictorial and dimensional data is subject to change without notice.

The information presented in this catalog is based on technical data and test results of nominal units. It is believed to be accurate and is offered as an aid in the selection of Gast products. It is the user's responsibility to determine suitability of the product for intended use and the user assumes all risk and liability whatsoever in connection therewith.

Gast can also provide CE compliant blowers with BSP threads, as well as customized blowers for specific applications. Consult a Gast Representative/Distributor for more information.

Environmental and application conditions may affect advertised life.

Warning:

Models Without Explosion-Proof Motors Should Not Pump Combustible Gases or Be Used In Combustible Ambients

Performance Table

MODEL/ SERIES	POWER RATING @ 60 Hz hp kW		FREE AIR FLOW				MAXIMUM PRESSURE				MAXIMUM VACUUM			
			cfm		m³/h		" H ₂ O		mbar		" H ₂ O		mbar	
			50 Hz	60 Hz	50 Hz	60 Hz	50 Hz	60 Hz	50 Hz	60 Hz	50 Hz	60 Hz	50 Hz	60 Hz
Standard Motor Mounted Models														
R1*	1/8	0,09	23	27	39	46	21	28.5	52	71	20	26.5	50	66
R2*	1/3, 1/2	0,25, 0,37	33	42	56	71	30	39	75	97	25	35	62	87
R3*	1/2	0,37	43-44	52-53	73-75	88-90	31-40	43-55	77-100	107-137	28-35	40-50	70-87	100-125
R4*	1	0,75	75	92	127	156	38	52	95	130	35	48	87	120
R4P*	1 1/2	1,1	110	127	187	216	50	65	125	162	45	60	112	149
R5*	2 1/2	1,86	133	160	226	272	50	65	125	162	47	60	117	149
R6*	2 1/2- 5	1,86- 3,73	180	207- 215	306	352- 365	40- 78	45- 105	100- 194	112- 262	50- 70	55- 88	125- 194	137- 262
R6P*	3 1/2- 5 1/2	2,6- 4,1	225- 245	265- 290	382- 416	450- 493	50- 85	30- 110	125- 212	75- 274	50- 85	35- 90	126- 212	87- 224
R6PP*	11	8,2	420	520	714	884	75	95	187	237	65	80	162	199
R7*	10	7,46	350	420	595	714	115	125	286	311	90	110	224	274
R7P*	18	13,4	666	795	1132	1351	90	105	284	262	85	95	212	237
R9*	15	11,3	585	680	994	1155	125	125	311	311	105	115	262	286
R9P*	30	22,4	1140	1350	1937	2294	110	125	274	311	100	110	249	274
High Pressure Motor Mounted Models														
R4H*	6	4,5	107	128	182	217	284	284	707	707	183	183	456	456
R6PS*	11	8,2	230	280	391	476	145	170	361	423	110	130	274	324
R7S*	18	13,4	350	420	595	714	170	200	423	498	130	150	324	374
R9S*	30	22,4	585	660	994	1121	208	222	518	553	142	149	354	371
Explosion Proof Motor Models														
R3105N-50	1/2	0,37	44	53	75	90	31	43	77	107	28	40	70	100
R4110N-50	1	0,75	74	92	126	156	38	51	95	127	35	48	87	120
R4310P-50	1	0,75	74	92	126	156	38	51	95	127	35	48	87	120
R4P115N-50	1 1/2	1,1	112	133	190	226	45	65	112	162	40	60	100	149
R5125Q-50	2	1,5	—	160	—	272	—	55	—	137	—	60	—	149
R5325R-50	2	1,5	133	160	226	272	50	65	125	162	47	65	117	162
R6130Q-50	3	2,2	180	215	306	365	75	60	187	149	65	70	162	174
R6340R-50	4	3,0	180	215	306	365	75	100	187	249	65	80	162	199
R6P155Q-50	5 1/2	4,1	235	280	399	476	80	95	199	237	65	85	162	212
R6P355R-50	6	4,5	232	280	394	476	80	100	199	249	65	85	162	212
R7100R-50	10	7,5	350	425	595	722	90	100	224	249	85	110	212	274
Separate Drive Models														
SDR4	4	3,0	147		250		110		274		90		224	
SDR5	10	7,5	240		408		152		379		120		299	
SDR6	15	11,2	300		510		155		386		135		336	

*Models equipped with UL and CSA certified motors. (except R1102K (12v DC))

Performance Curves - Low Range for Pressure/Vacuum

Motor mounted series R1, R2, R3, R4, R4P, R5

Performance at 60 Hz

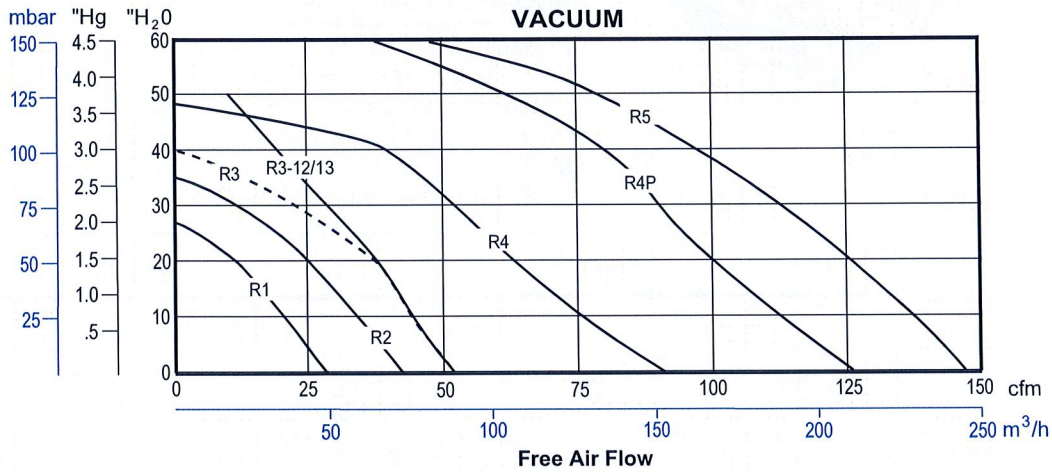
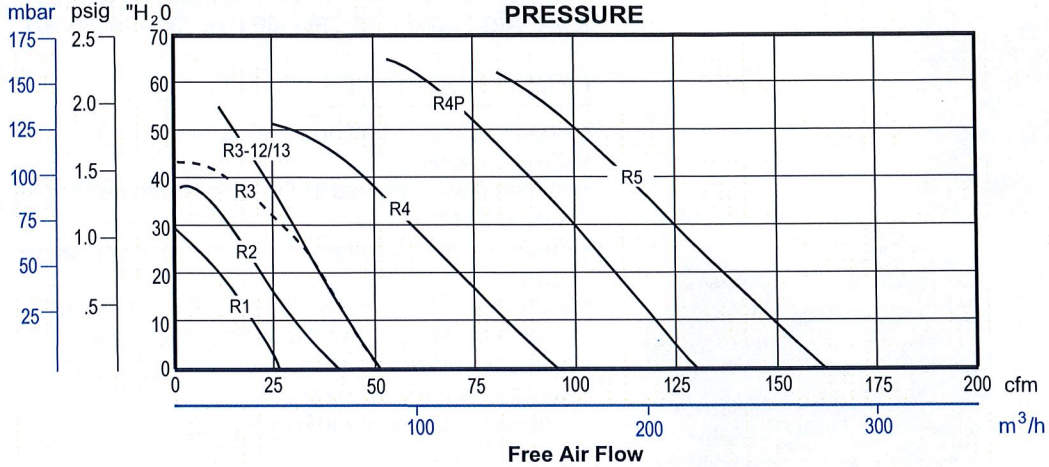

Gast advertises blower performance in Free Air Flow, or air subjected to only atmospheric pressure. (See above curves)

Some blower manufacturers advertise vacuum performance in CFM Inlet Air - measurement of the suction of air at a specific temperature at the inlet port and a specific discharge pressure at the exhaust port, which can be perceived as enhanced performance over Free Air Flow rated blowers. Therefore, we are also providing the following vacuum performance for Gast blowers in CFM Inlet Air for comparison to other blower manufacturer's advertising.

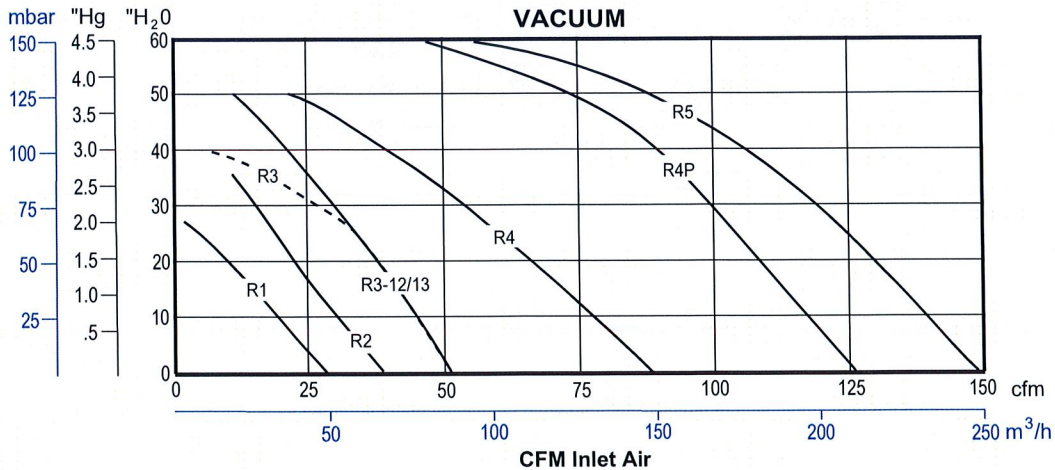

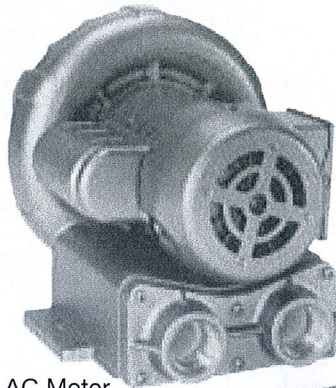

AC Motor

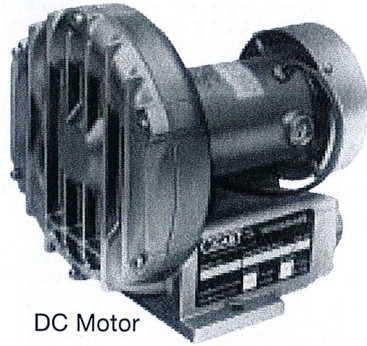

DC Motor

R1 SERIES

MODELS R1102, R1102C, R1102K

MAX. PRESSURE – 28.5"H₂O (60 Hz), 21"H₂O (50 Hz)

MAX. VACUUM – 26.5"H₂O (60 Hz), 20"H₂O (50 Hz)

MAX. AIR FLOW – 27 CFM (60 Hz), 23 CFM (50 Hz)

PRODUCT FEATURES

- Rugged construction, low maintenance
- Oilless operation
- UL and CSA approved TEFC motors with permanently sealed ball bearings
- Automatic restart thermal protection on single phase AC motors
- Estimated 3,000 hour brush life on 12 volt DC motor
- Can be operated with no air flow through unit.
- Aluminum blower housing, impeller and cover
- Can be mounted in any plane
- Inlet and outlet have internal muffling

RECOMMENDED ACCESSORIES

- Pressure gauge AJ496
- Inlet Filter AJ126B (pressure)
- Vacuum gauge AJ497
- Inline filter AJ151A (vacuum)
- Muffler AJ121B
- K899 foam replacement kit for R1102

Product Dimensions (in. mm)

MODELS R1102,
R1102C, R1102K,

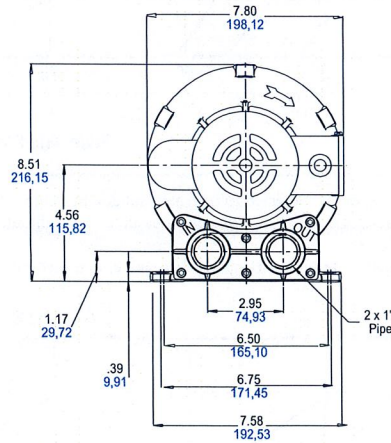
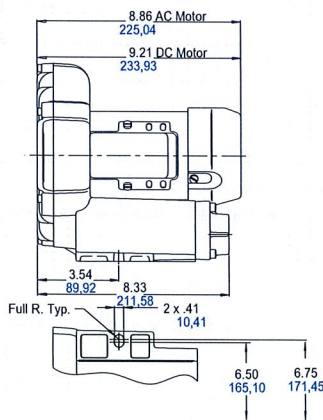

Product Specifications

MODEL NUMBER		R1102	R1102C	R1102K
Motor Enclosure		TEFC	TEFC	TEFC
HP/kW	60 Hz	.125/0,09	.125/0,09	.125/0,09
	50 Hz	.10/0,07	-	-
Voltage	60 Hz	115/208-230-1	115-1	12V DC
	50 Hz	110/220-240-1	-	-
Amps	60 Hz	2.0/1.1-1.0	1.8	19 @ 12V DC
	50 Hz	2.0/1.1-1.0	-	-
Starting Amps	60 Hz	8.5 @ 115V	9.7	145 @ 12V DC
	50 Hz	8.6 @ 220V	-	-
Insulation Class		B	B	H
Recommended NEMA Starter Size		00/00	00	-
Net Weight (lbs/kg)		16/7,3	16/7,3	16/7,3

Product Performance

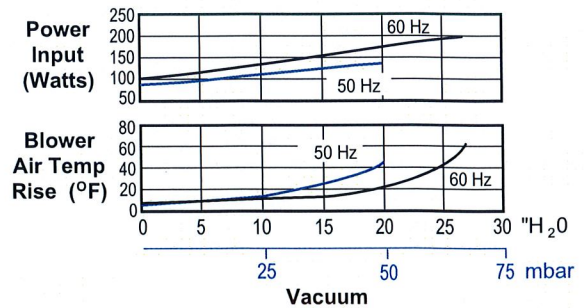
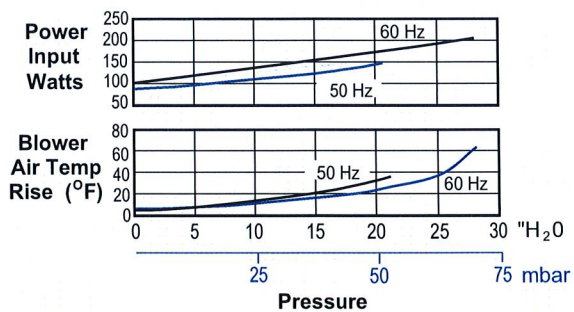
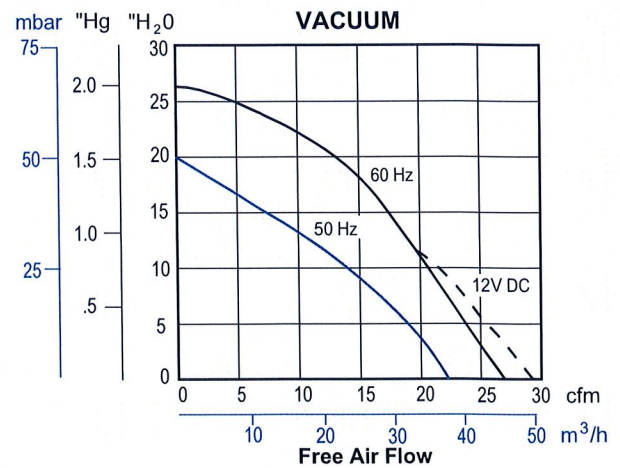
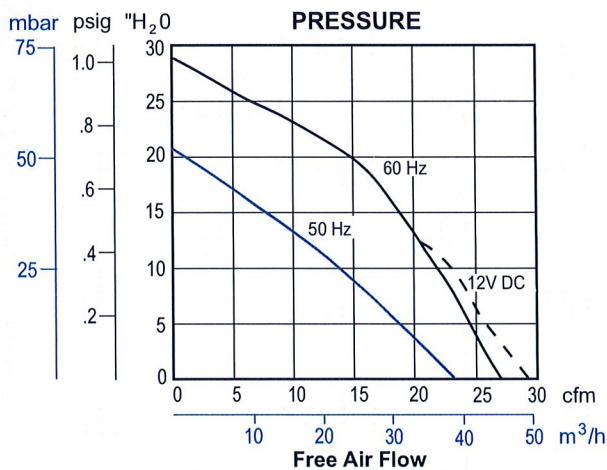

Appendix C
Field Checklist Form

MONITORING CHECKLIST

Customer Name

Address

NIBBLER® CBP

DATE _____ TIME _____ INSPECTION ID _____

DATE LAST CHECKED _____ DAYS THIS PERIOD _____ INSPECTED BY _____

ROUTINE	Δ				
PROBLEM	Δ	CORRECTED	Δ	NEEDS CORRECTION	Δ
		NEEDS F/U	Δ	EMERGENCY	Δ
		NO F/U	Δ	NOT URGENT	Δ

THIS FORM SHALL BE COMPLETED BY THE SYSTEM MANAGER AND SUBMITTED TO THE OWNER & MANUFACTURER UPON COMPLETION OF EACH INSPECTION.

BLOWER FAN:

FAN	_____	OK	_____	MALFUNCTION
FAN AIR INTAKE FILTER	_____	CLEAN	_____	NEEDED CLEANING/WAS CLEANED

NIBBLER CBP. RECIRC. COLLECTION SPOON:

OPENING DISTANCE FROM CENTER DRAFT TUBE:	_____	”	CORRECT: YES / NO
IF NO, CHANGED TO:	_____	”	_____

SLUDGE LEVELS IN TANKS:	ACCUM. SLUDGE	FLOATING MAT	COLOR
SEPTIC TANK:			
1 ST COMP.	_____	_____	_____
2 ND COMP.	_____	_____	_____

Vent Cap Installed in the _____ Outlet or _____ Inlet

PH _____ D.O. _____ Temp _____ C°

EVIDENCE OF EFFLUENT SURFACING: YES / NO _____

OBSERVATION OF LIQUID IN DRAINFIELD TEST PORTS: #1 _____ ” #2 _____ ”

OBSERVATIONS: _____

Appendix D

Glossary

GLOSSARY OF TERMS

Advanced Treatment Unit - A Sand Filter, Recirculating Gravel Filter, or other device which is designed to reduce waste levels to less than 30 mg/L (BOD₅, TSS & O&G) Many of these units will reduce waste strength levels to less than 10mg/L.

Aerobic - (1) A condition where free oxygen or dissolved oxygen is present. (2) Requiring or not destroyed by free oxygen. Generally referred to organisms, which use free oxygen for respiration.

Air Lift Pump - A pump that lifts water using air. In NIBBLER Jr[®] systems an air lift pump is typically a pipe section with a smaller air tube in the center. The air tube delivers a large volume of air below the liquid level inside the larger pipe, which displaces the liquid in the large pipe and forces it out the top,

Anaerobic - (1) A condition where free oxygen or dissolved oxygen is not present. (2) Requiring or not destroyed by the absence of free oxygen. Generally referring to organisms, which do not require free oxygen for respiration.

ATU - Aerobic Treatment Unit - Typically a proprietary devise which uses air to treat wastewater.

Blackwater - Generally refers to flows from bathroom fixtures, i.e. toilets, sinks & urinals.

Baffle - Typically a plastic or concrete device mounted at the inlet or outlet of a tank wall intended to collect/discharge water from/to the clear zone in the tank.

BOD₅ - Biochemical Oxygen Demand over a five-day test period. Generally refers to the amount of oxygen required by bacteria to stabilize organic matter under aerobic conditions It is determined entirely by the availability of the material in the wastewater be used as food and by the amount of oxygen utilized by the microorganisms during oxidation.

Bulking -As a sludge blanket matures it will produce gasses. As the gasses release they produce a zone of poorly settled flocculated material. This process is referred to as bulking.

Clear Zone - Typically the middle zone in the tank. Represents the clearest liquid in the tank.

Drainfield - Generally refers to a subsurface method or wastewater disposal.

Drawdown - Refers to the process of pumping a tank down a specific volume over a measured time. This information is then used to calculate a pump discharge rate (in GPM). A drawdown should be poerformed with the tank half full and the system components hooked up, as they would be for normal system operation.

Facultative - (1) Able to function both in the presence or absence of free oxygen. Generally refers to organisms, which can use free oxygen or bound oxygen for respiration.

Greywater - Greywater represents the flows from sources other than bathroom waste. Typically refers to waste flow from the kitchen and laundry.

GPD - Gallons per day.

GPM - Gallons per minute.

High Strength Waste - Generally refers to wastewater flows which have a BOD₅ >150 mg/L, TSS > 80 mg/L and O&G >20 mg/L.

Media - Typically a plastic material used as a surface area for the growth of large microorganism population. May be trickle media (exposed to air), or submerged media (below the liquid level).

O&G - Oil and grease.

pH - An expression of the intensity of the alkaline or acidic strength of the water.

Septic Tank - Tank designed to retain solids (floatable and sinkable). Generally designed to have a 1.5 to 2 days detention time based on design flows.

TSS - Total Suspended Solids measured in mg/L or parts per million (PPM).

Dissolved Oxygen

The Dissolved Oxygen (DO) level in wastewater is an important aspect of aerobic treatment and a good tool for troubleshooting. However, DO is a very dynamic parameter and can vary considerably from system to system and from component to component. For each system you work on, you will develop a normal set of operating parameters (including DO). The following general statements are related to DO and the NIBBLER[®] CBP system:

- DO measurement is affected by; temperature, barometric pressure (altitude), and salinity. You must input the local altitude into the meter before you measure the DO in the wastewater.
- The DO in the various NIBBLER[®] CBP components can be affected by; the waste strength of the influent, the aeration, the DO in the source water, and ground water infiltration.
- In a grease trap or septic tank the DO is generally between 0.0 and 0,5 mg/L and almost always less than 1 mg/L. However, the DO in a grease tap or septic tank with a Nibbler Jr[®]. installed in it will be higher than this and will be dependent of the waste strength, flow volume, and the recirculation ratio,
- The DO in a NIBBLER[®] CBP unit varies with depth, waste strength, and maturity of the organism population (food to micro-organism ratio). The DO in the NIBBLER Jr[®] unit generally ranges between 1 and 3 mg/L (not in the draft tube, and in mature system older than 2 months). In a properly operating NIBBLER[®] CBP system you will generally find that as you increase in depth the DO decreases. The DO in the sludge at the bottom of the tank may

approach zero. The DO in the NIBBLER[®] CBP unit is directly affected by the waste strength and re-circulation ratio.

High DO: It is possible for a NIBBLER[®] CBP unit to appear to have a very high DO (8-10 mg/l) and have very poor treatment occurring in the unit. If a vent line is obstructed the NIBBLER[®] CBP unit may receive poor aeration when the lids are closed. When the lid is opened, the unit appears to have excellent aeration. Since the unit has been operating without good aeration, there will be a small population of aerobic organisms. Therefore, the oxygen level will rise to near saturation levels without a hungry population of organism there to stabilize it. In addition, the effluent quality will not be as good and there is likely to be an odor present.

As previously noted the DO in different NIBBLER[®] CBP systems can vary. With each system you will develop a set of normal operating parameters including DO. Keeping a good record of the systems performance will help make the long term monitoring and maintenance easier.

